

9528

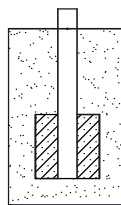

9528N

9528N

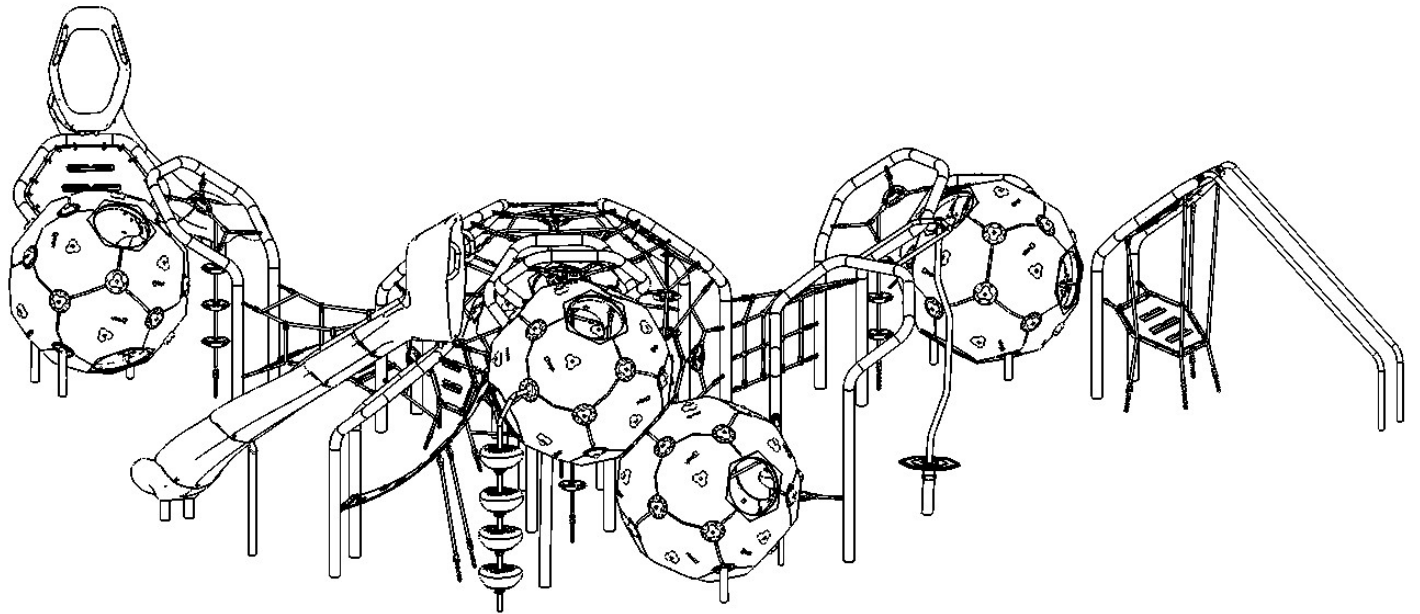
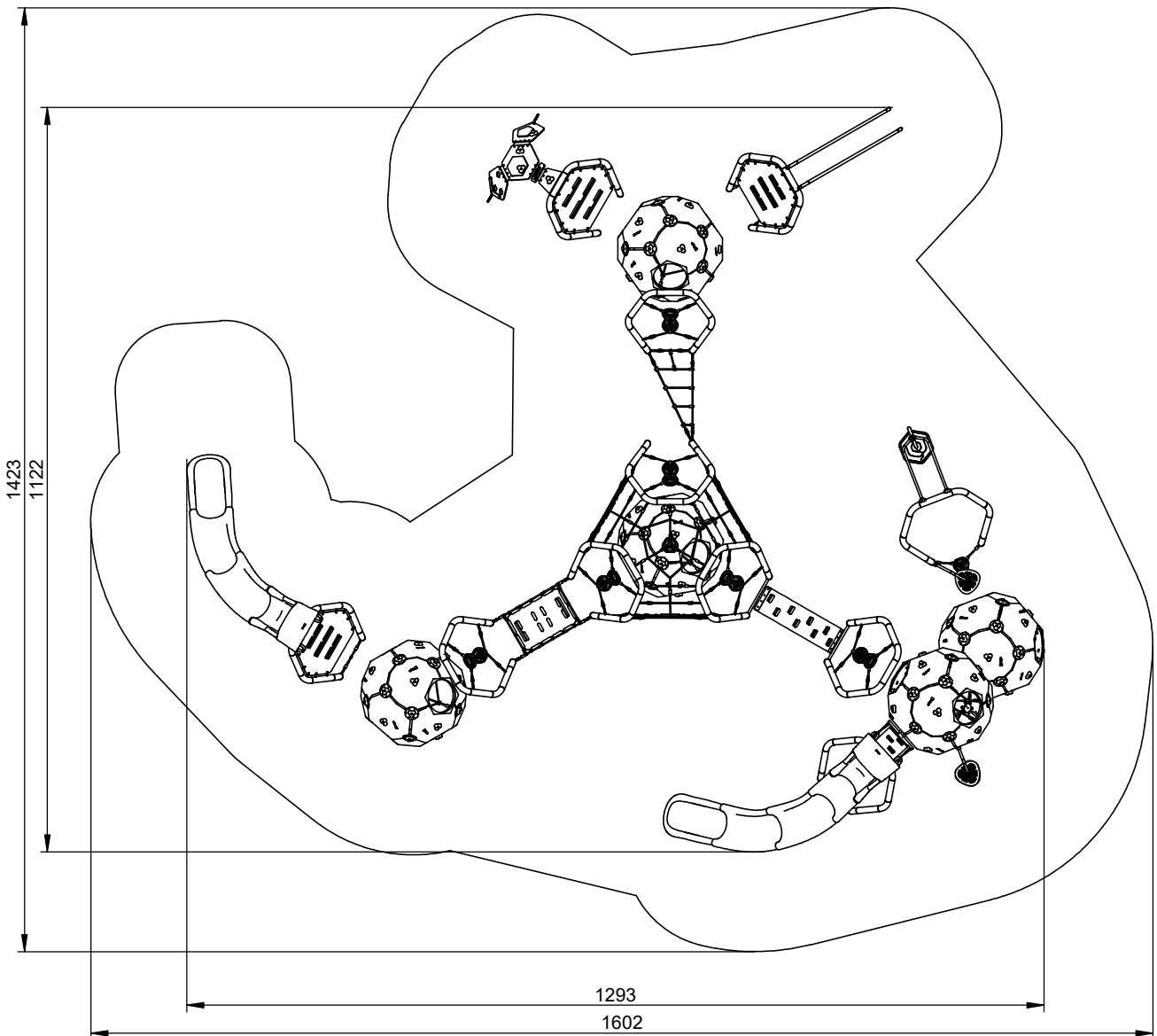
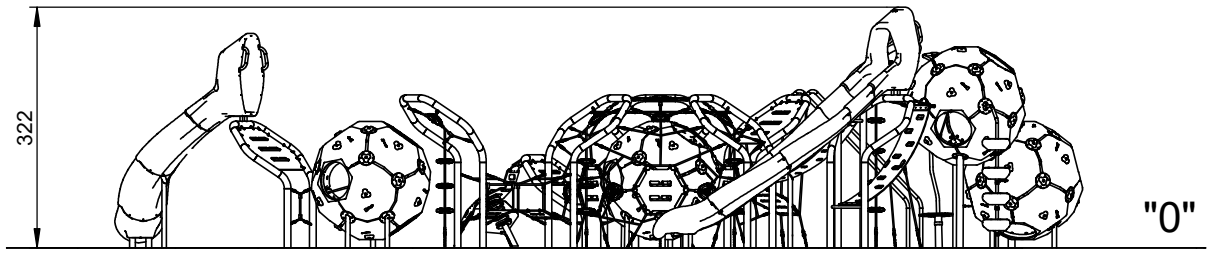

9528N

B25 1,7m³

min. 48H

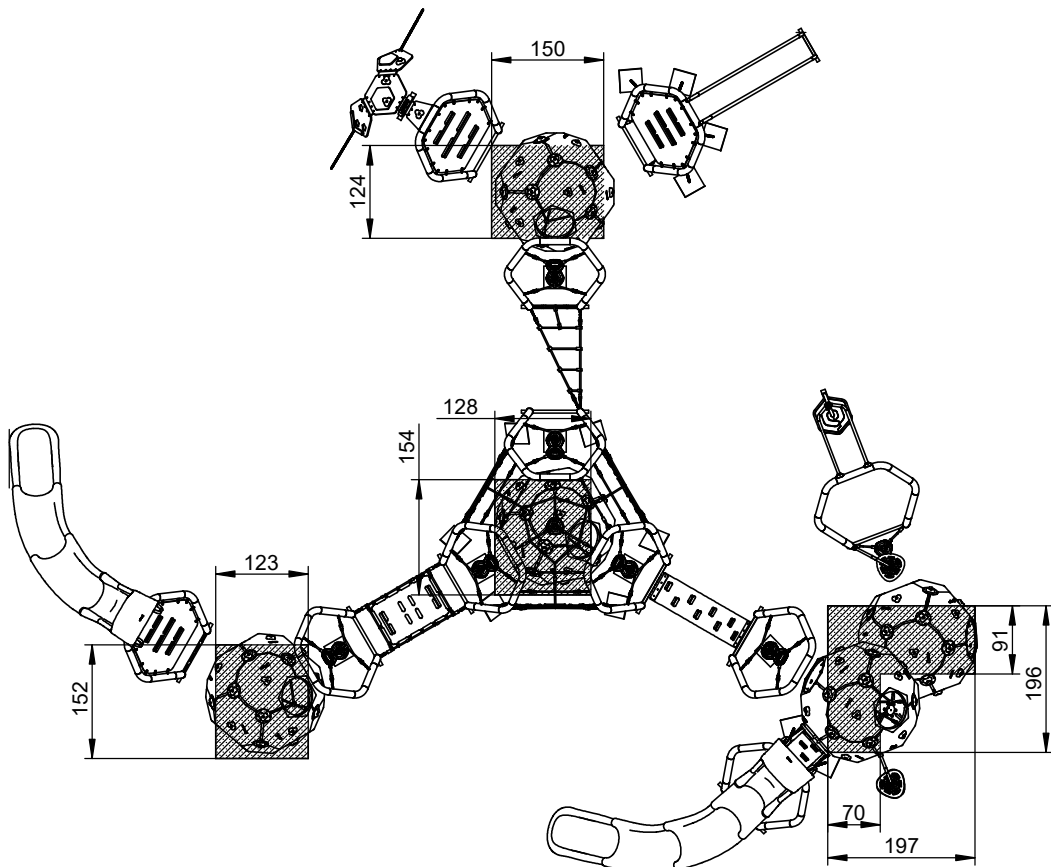
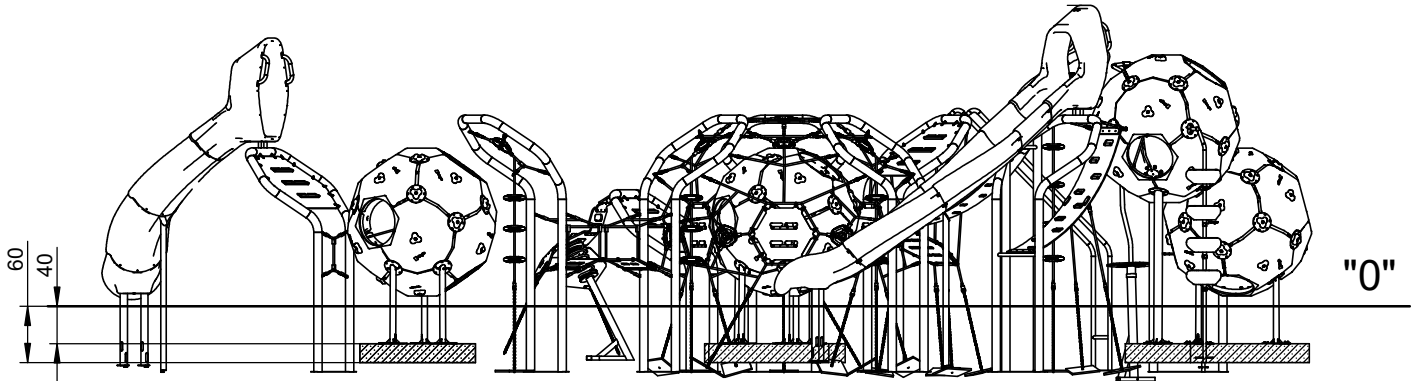
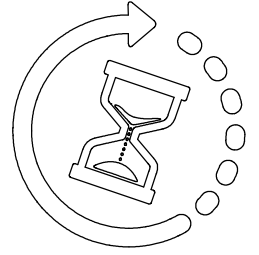
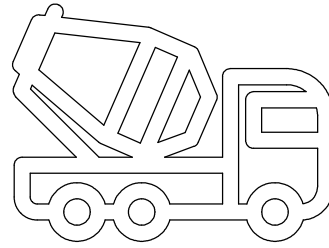
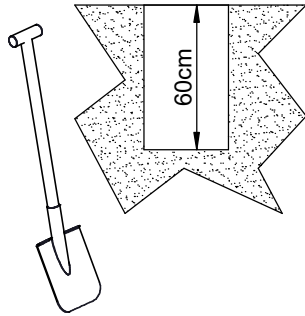

9528N

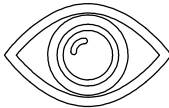

"0"

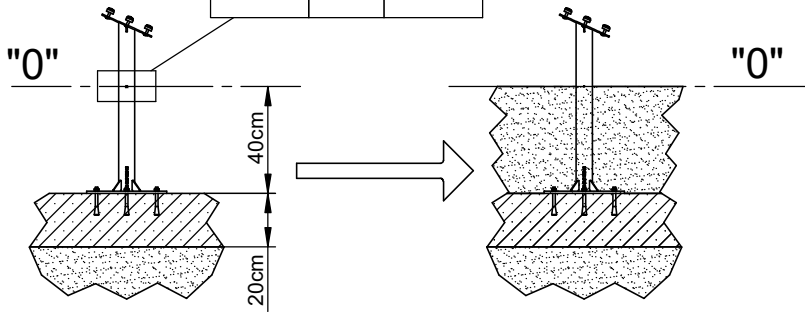

Nr	Element		
61		-	KL105 (OC)

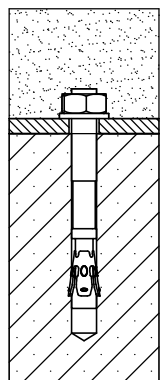
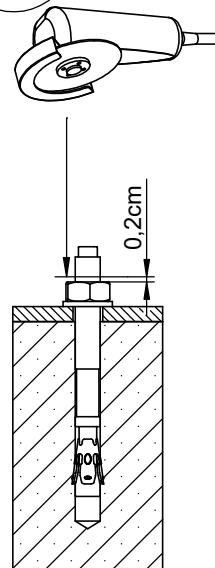
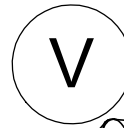
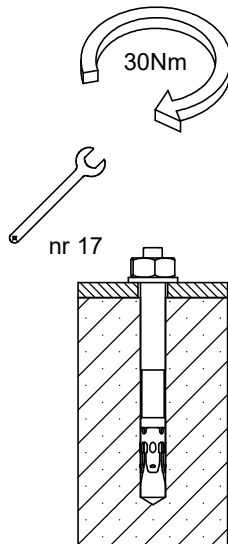
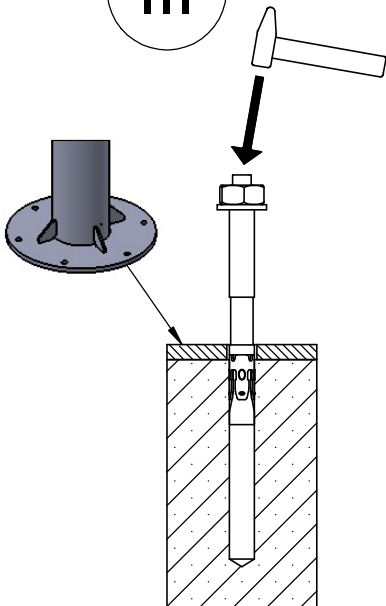
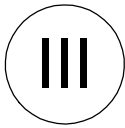
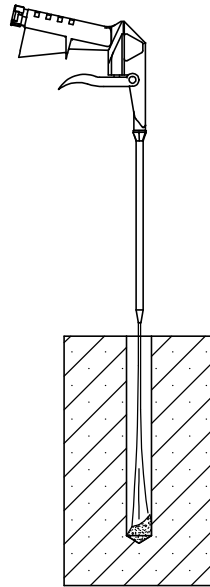
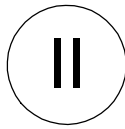
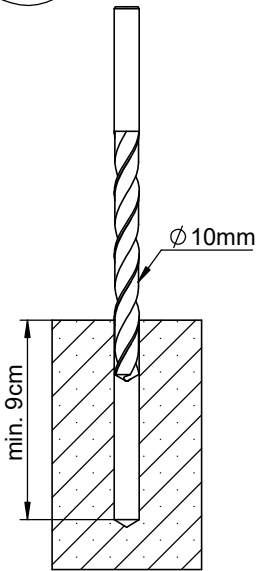
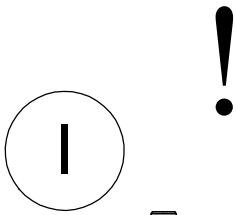

9528N

B25 3,5m³

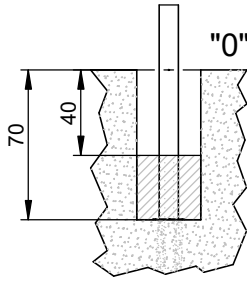
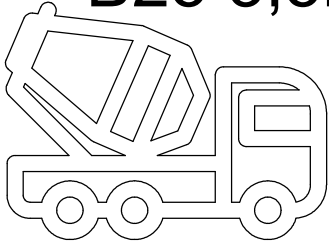

min. 48H

