

9527

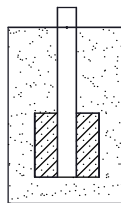

9527N

9527N

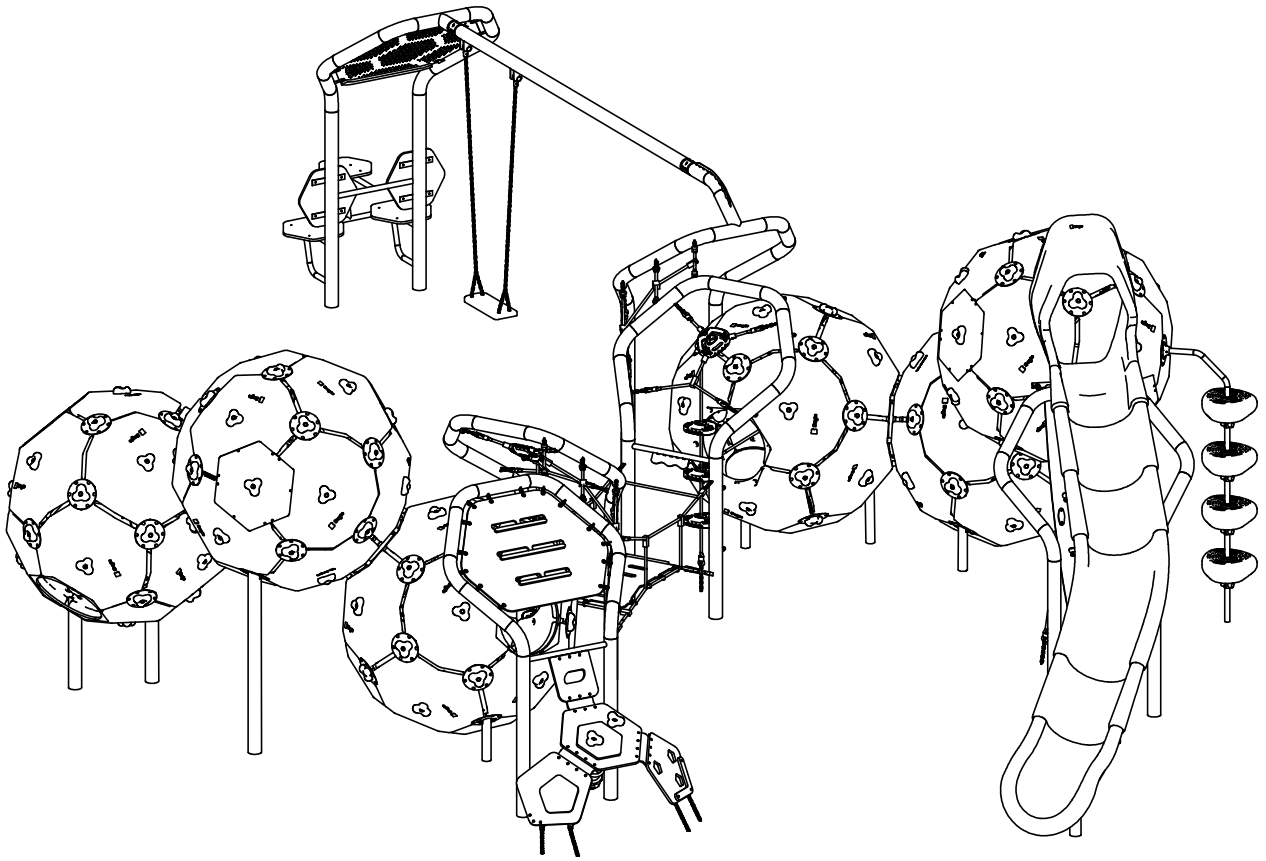
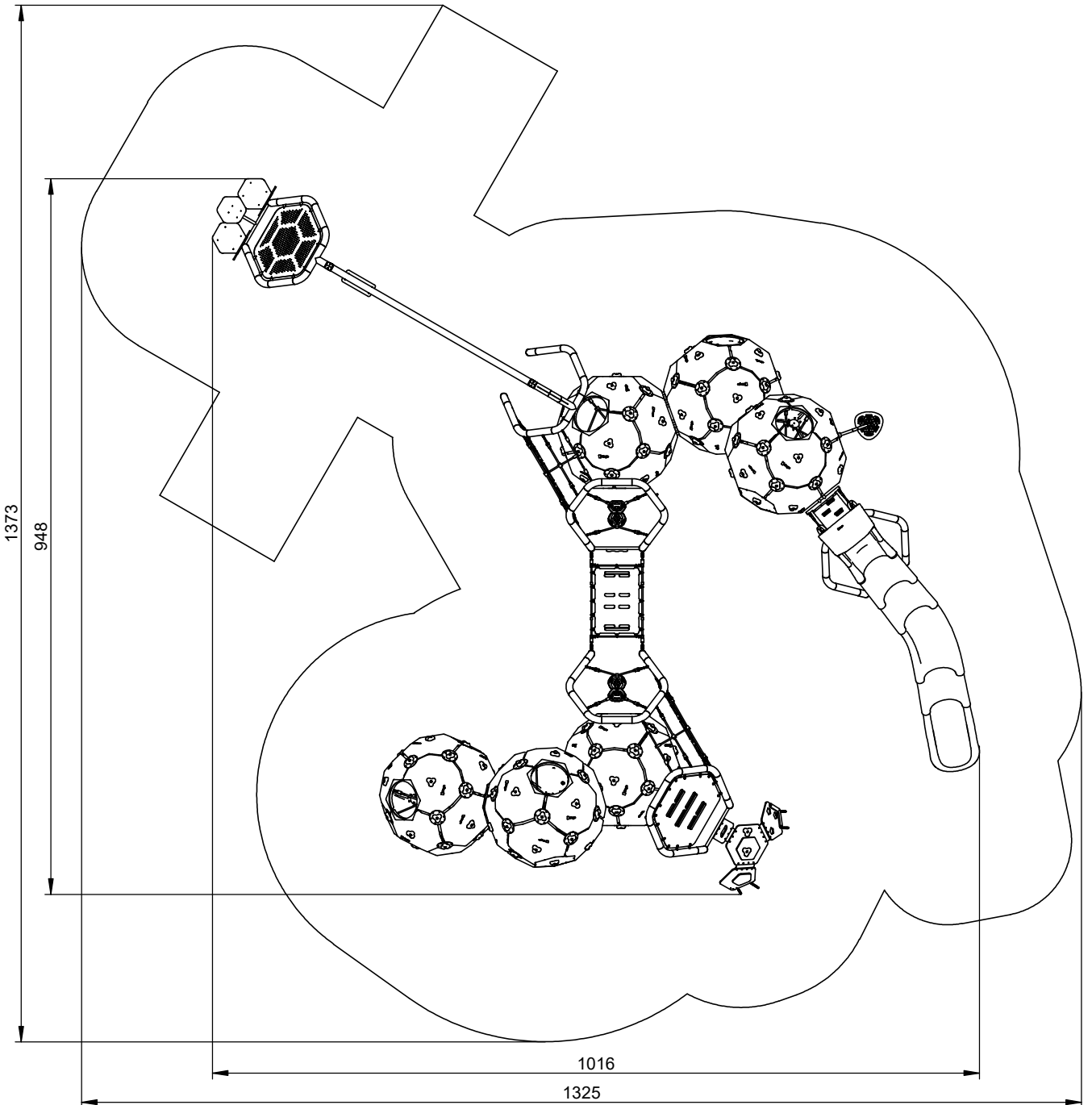
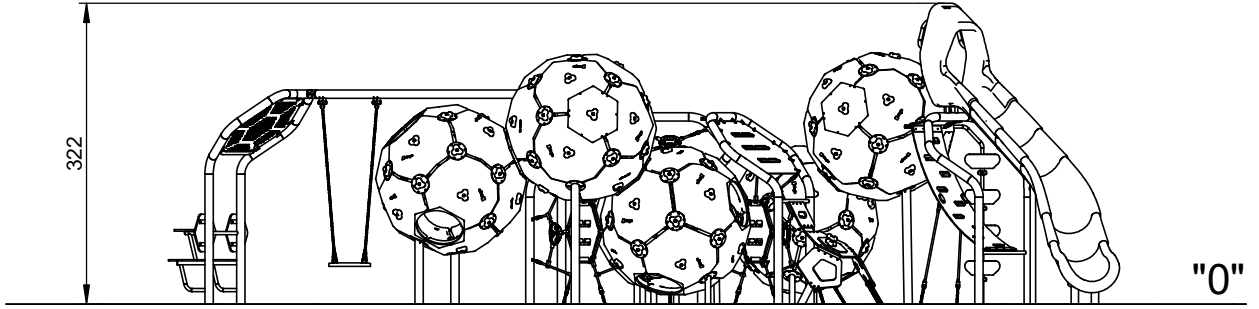

9527N

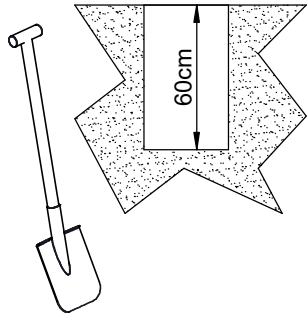

B25 0,7m<sup>3</sup>

min. 48H

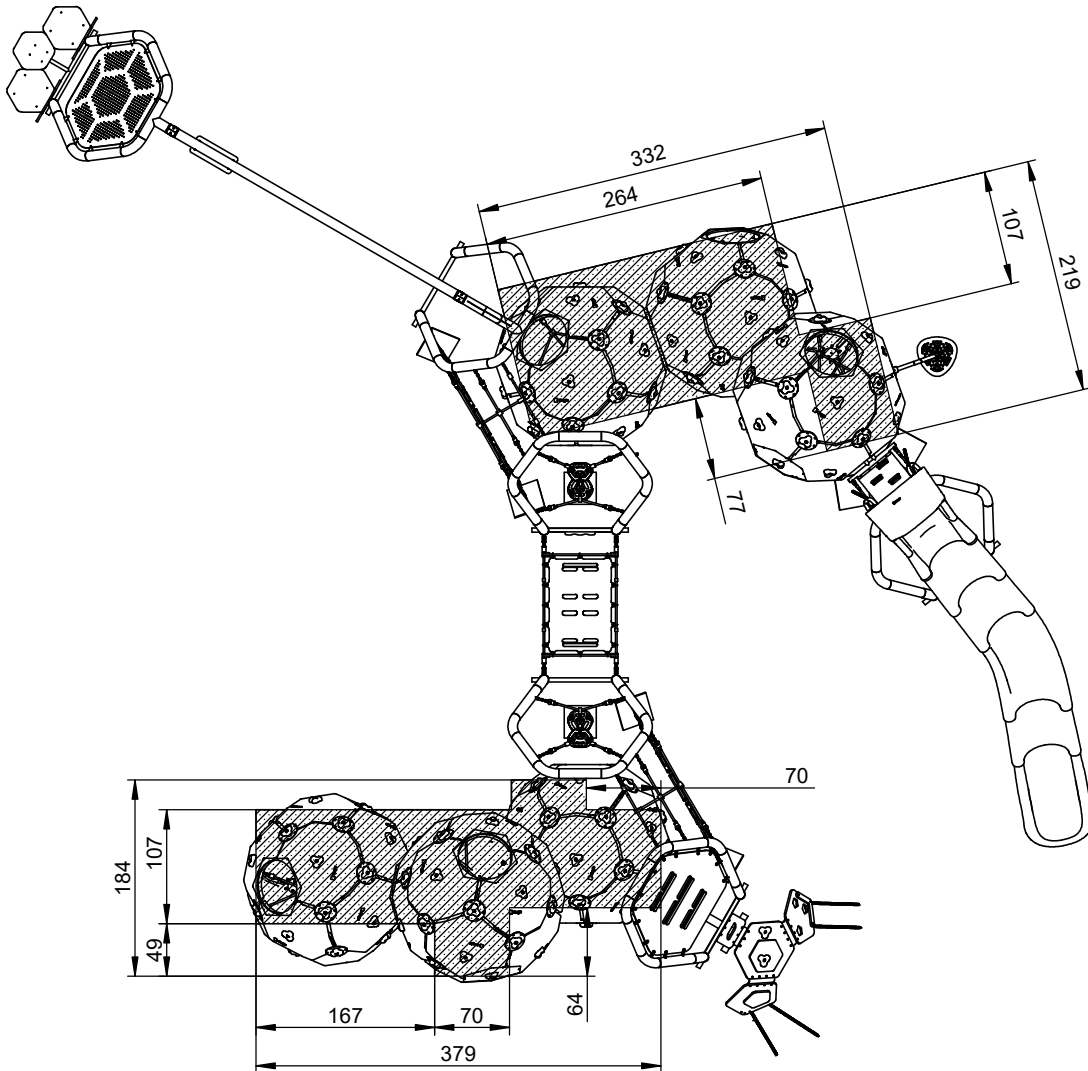
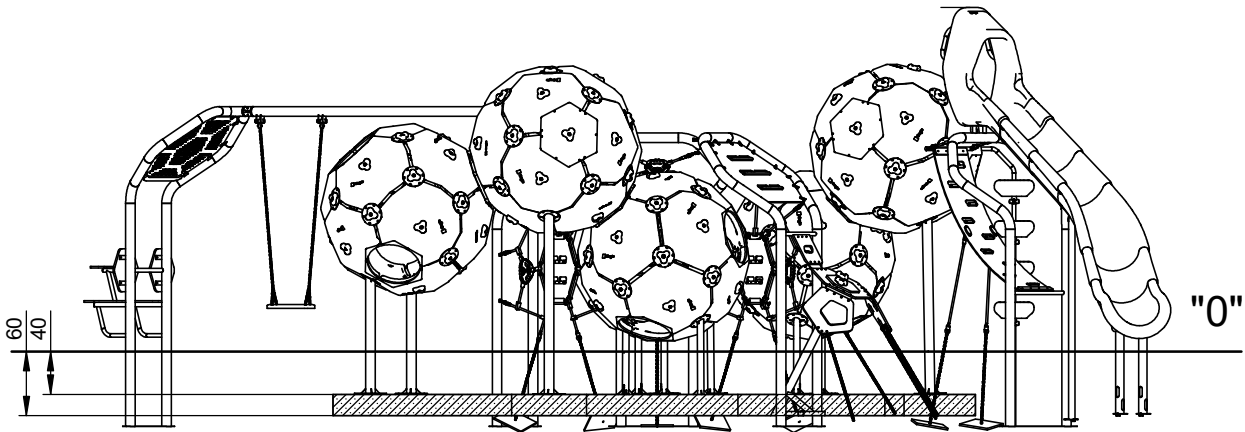
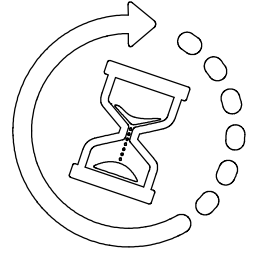
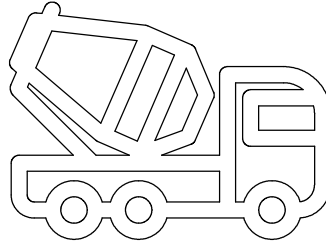

9527N

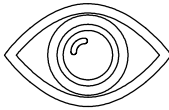

"0"

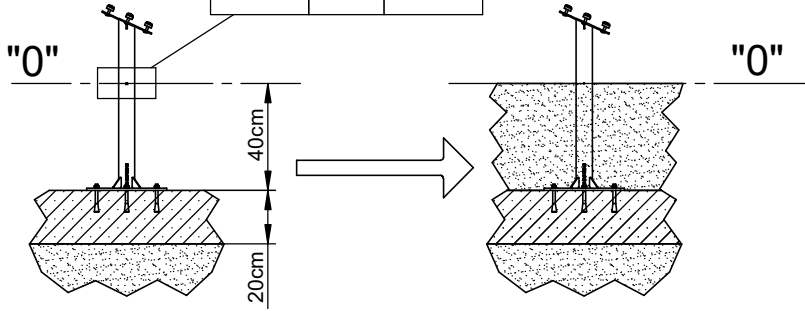

Nr	Element		
61		-	KL105 (OC)

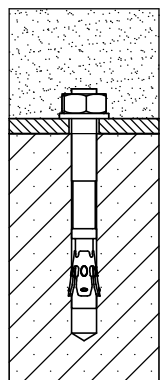
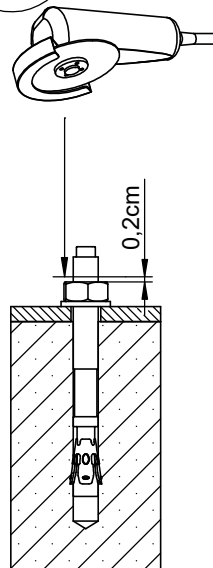
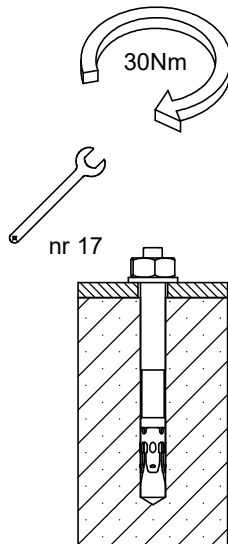
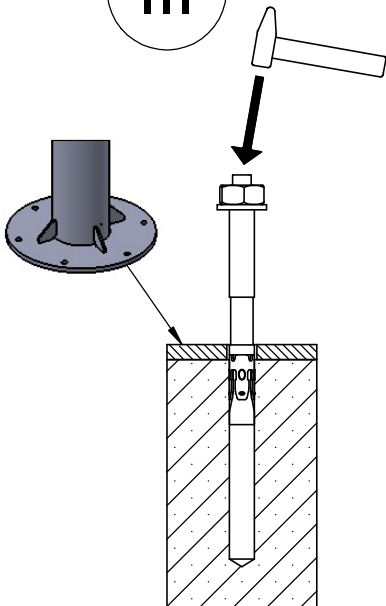
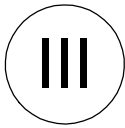
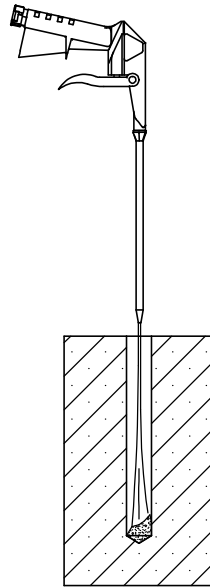
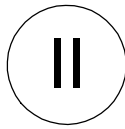
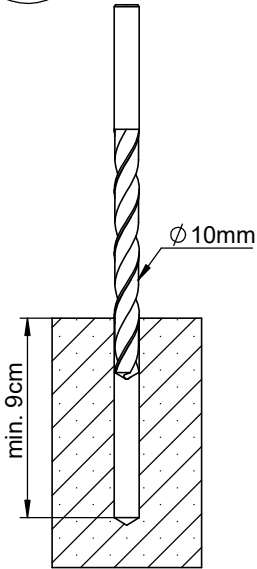
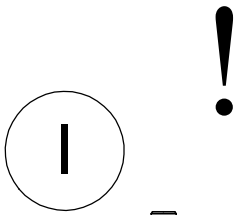

9527N

B25 2m<sup>3</sup>

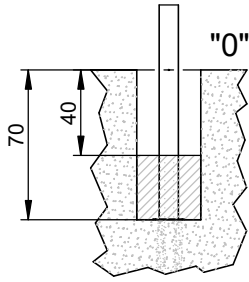
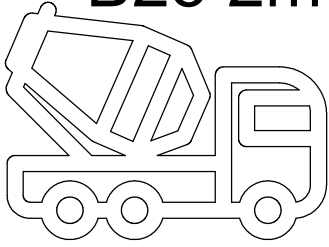

min. 48H

